

MOTORE: LDW 602 M - TAVOLA: A

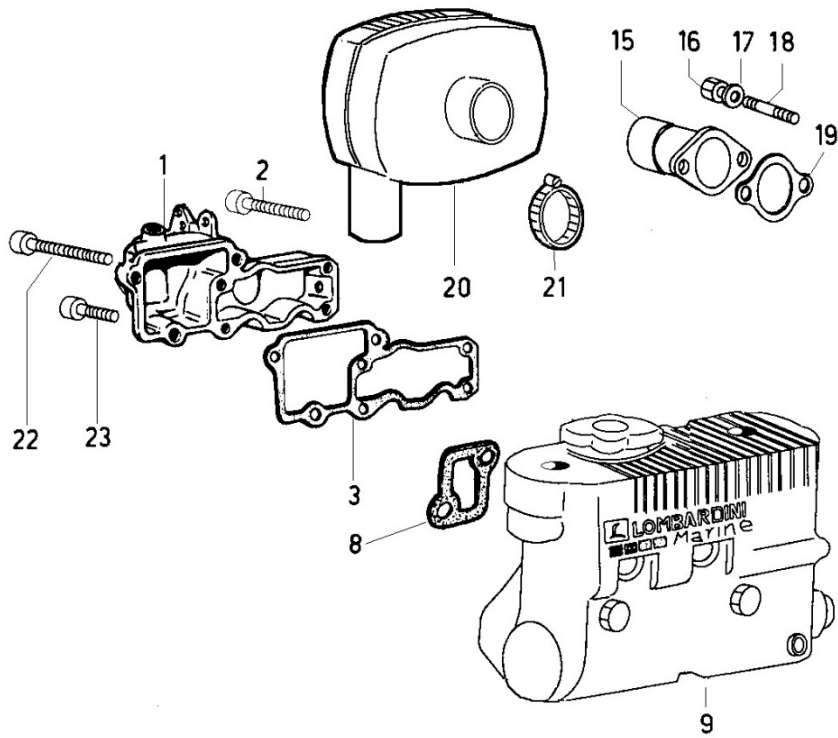

MOTORE: LDW 602 M - TAVOLA: B

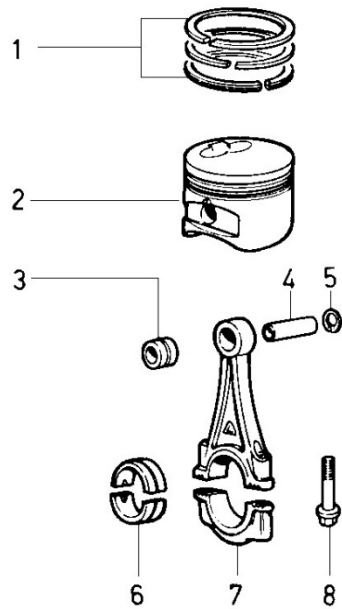

MOTORE: LDW 602 M - TAVOLA: C

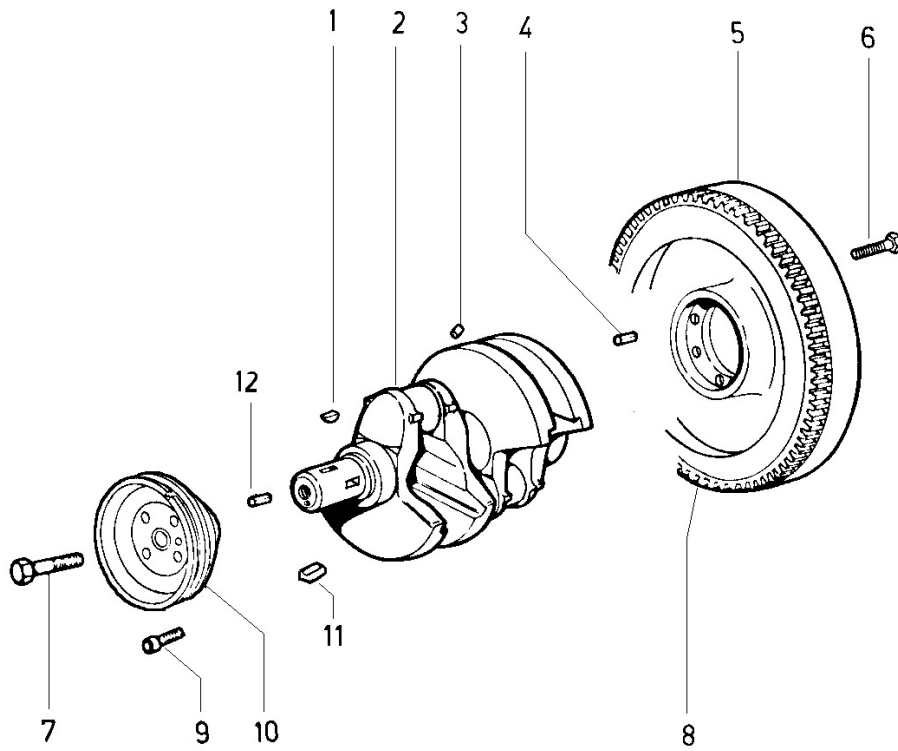

MOTORE: LDW 602 M - TAVOLA: D

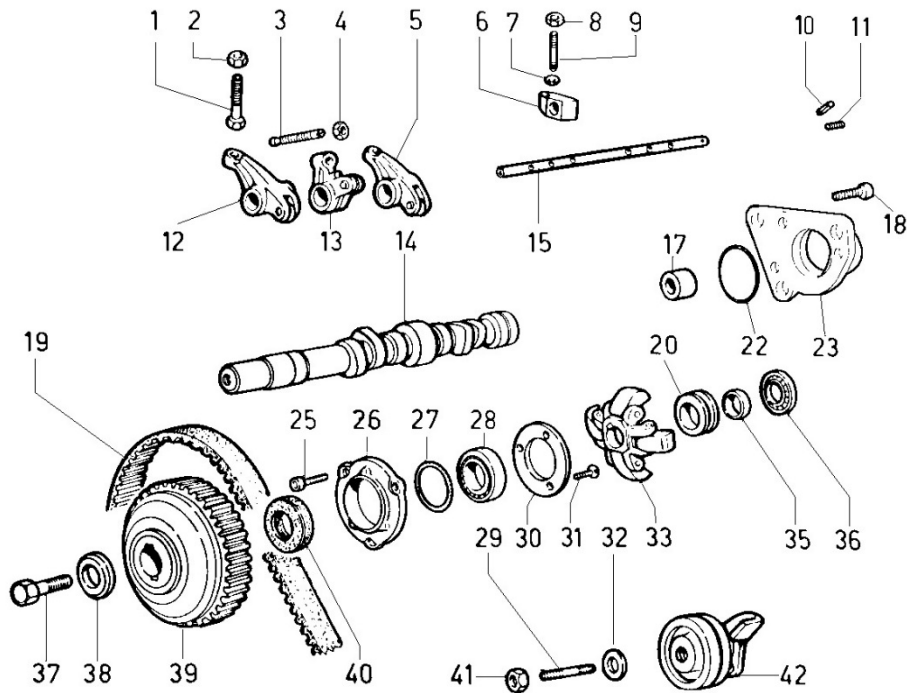

MOTORE: LDW 602 M - TAVOLA: E

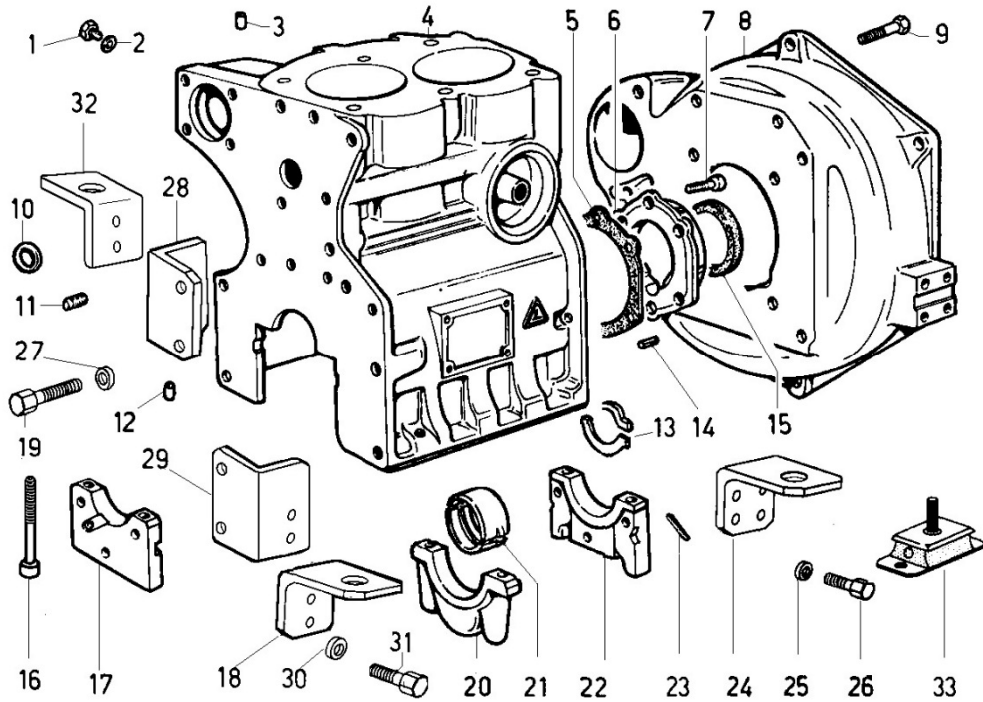

MOTORE: LDW 602 M - TAVOLA: F

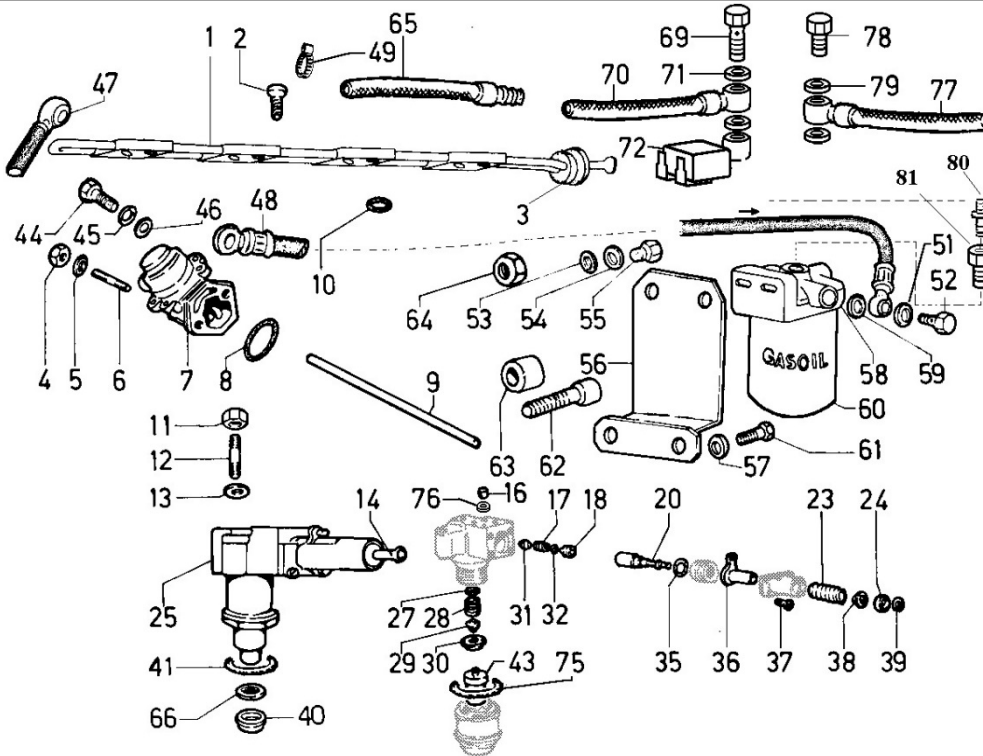

MOTORE: LDW 602 M - TAVOLA: G

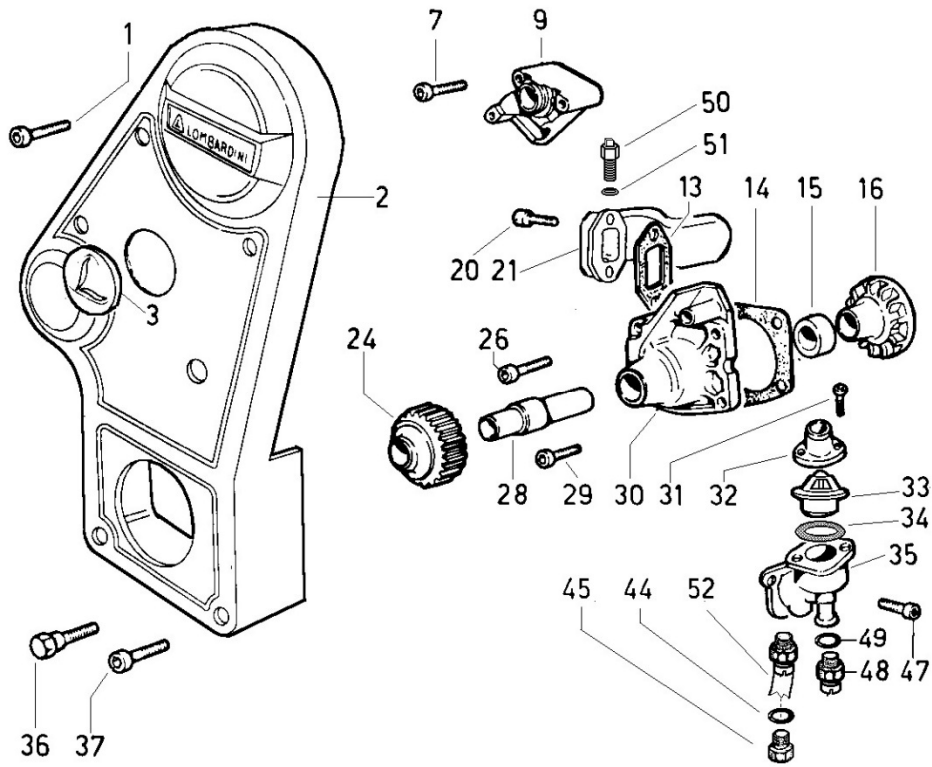

MOTORE: LDW 602 M - TAVOLA: H

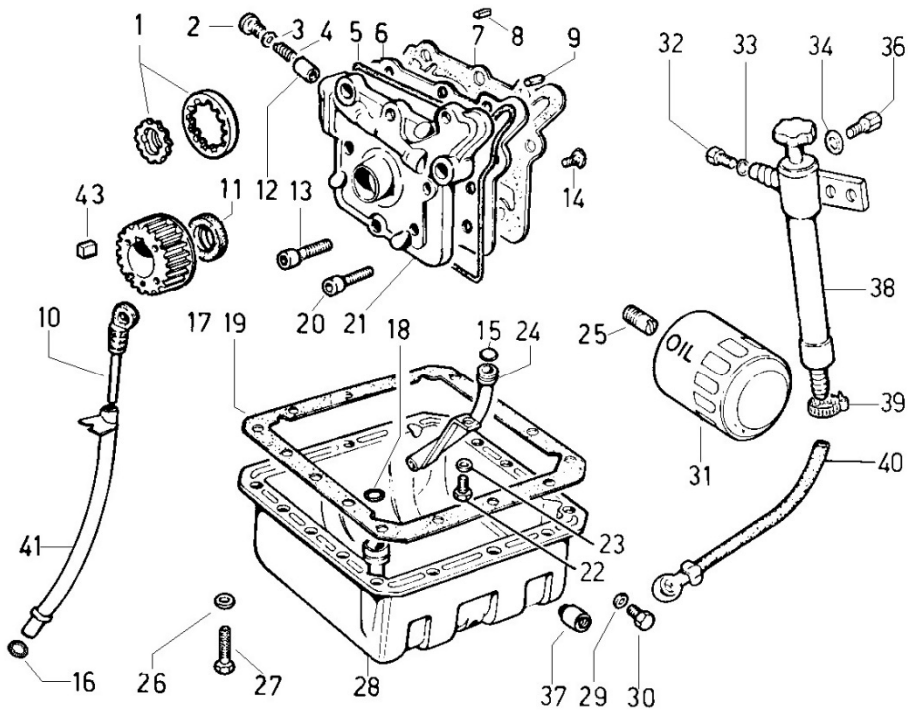

MOTORE: LDW 602 M - TAVOLA: I

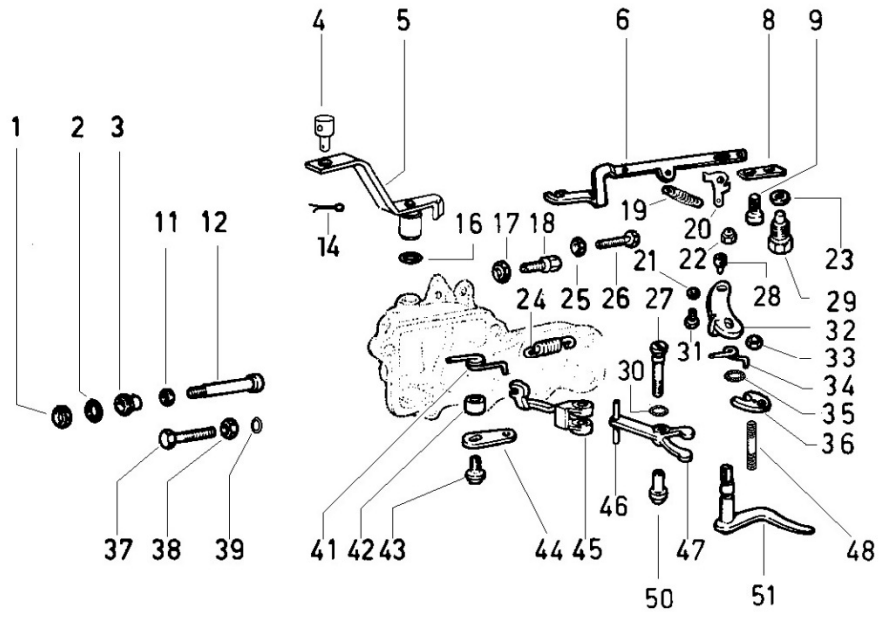

MOTORE: LDW 602 M - TAVOLA: L

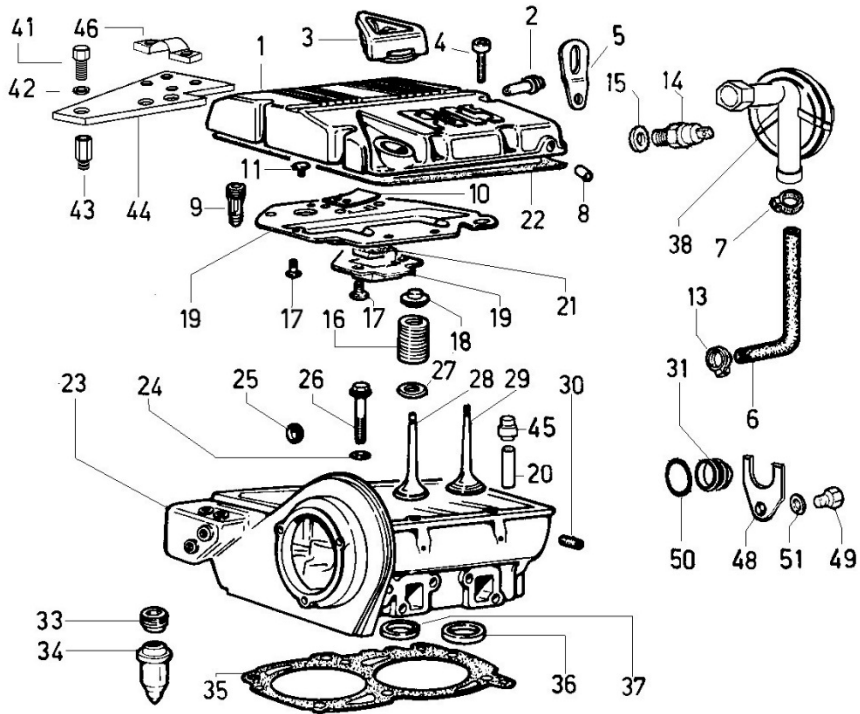

MOTORE: LDW 602 M - TAVOLA: M

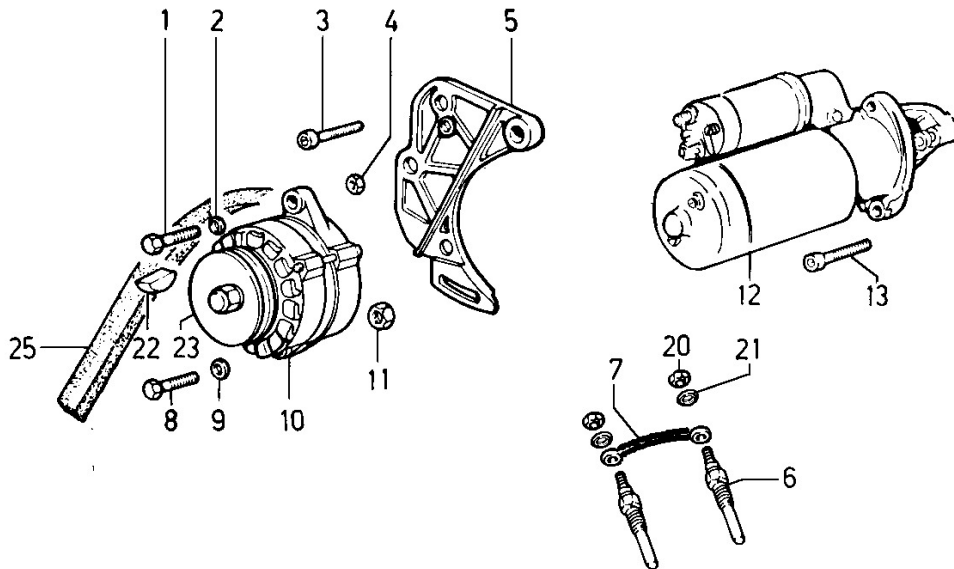

MOTORE: LDW 602 M - TAVOLA: N

N

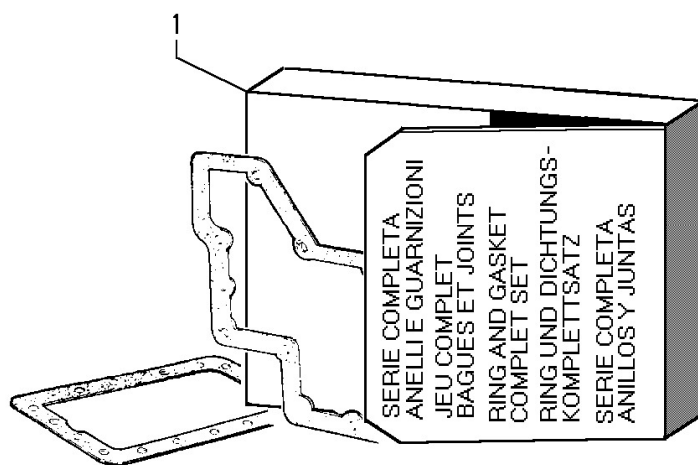

MOTORE: LDW 602 M - TAVOLA: P

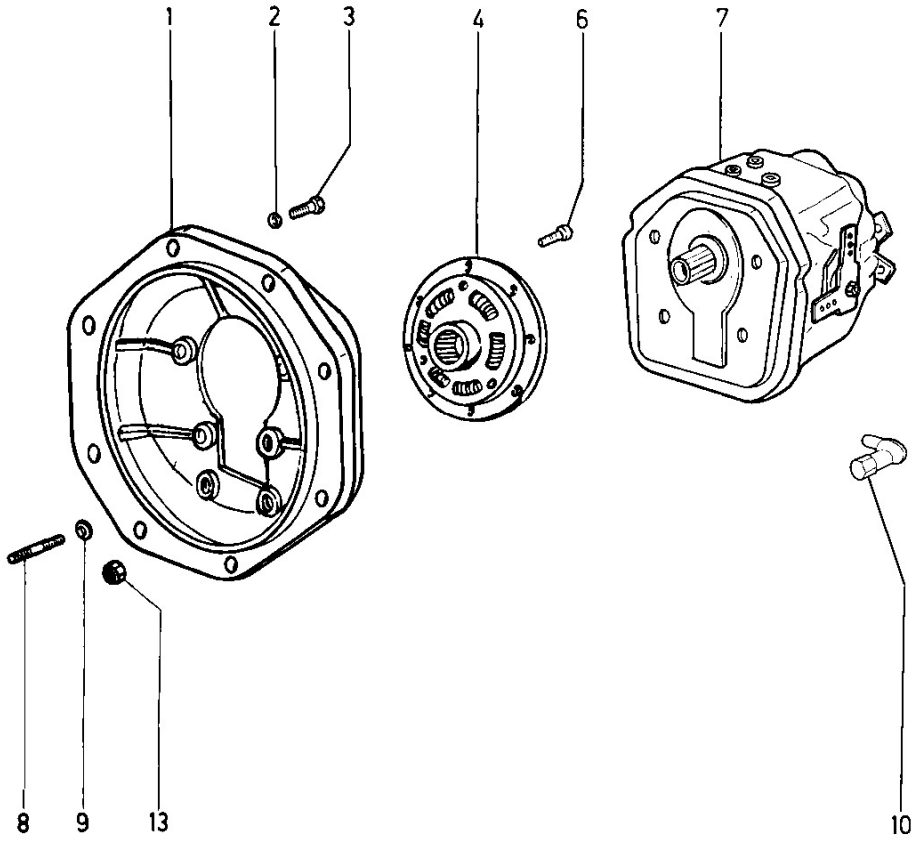

MOTORE: LDW 602 M - TAVOLA: Q

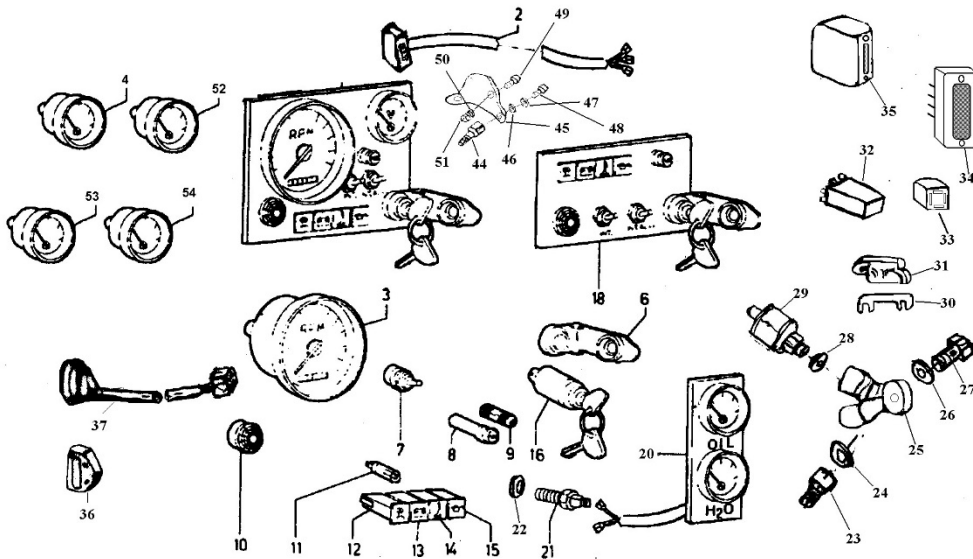

MOTORE: LDW 602 M - TAVOLA: R

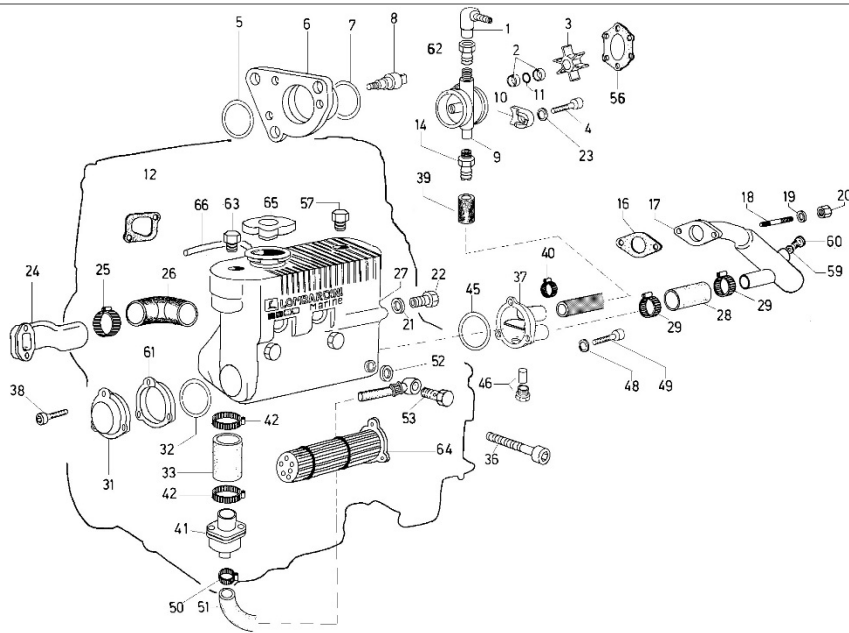

MOTORE: LDW 602 M - TAVOLA: S

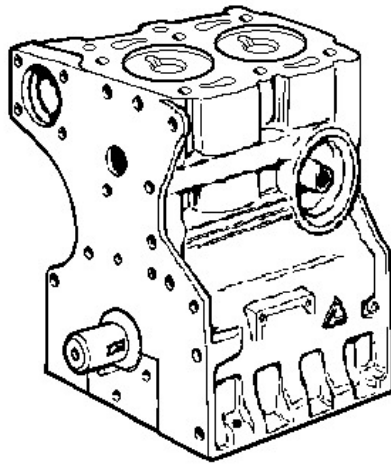

ATTENZIONE: LO SHORT BLOCK E' COMPOSTO DA BASAMENTO, ALBERO MOTORE, BIELLE E PISTONI GIA' PREMONTATI
ATTENTION: THE SHORT BLOCK IS BUILT-UP BY CRANK-CASE, CRANK-SHAFT, CONNECTING RODS AND PISTONS ALREADY ASSEMBLED.